

CONTENTS

The Roll & Hill Pendant 02
Lighting Assembly

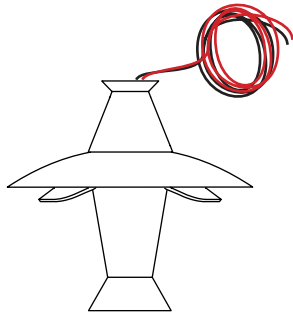

(x2) 8-32 Screw



(x7) Wago Connector



(x1) Glass diffuser

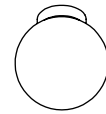

(x1) Canopy with crossbar assembly

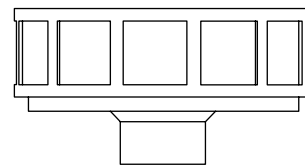

Threaded rod and cover tube

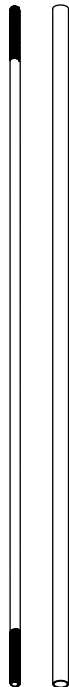

(x1) Glass (Tulip or Globe)

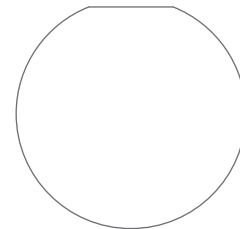
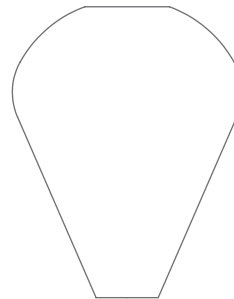

(x2) Toggle anchor
On 240V fixtures only

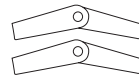

(x2) Wood screw
On 240V fixtures only



(x2) Long 8-32 screw
On 240V fixtures only



(x2) Metal screw
On 240V fixtures only



SAFETY INFORMATION

Suitable for dry or damp locations
Maximum ambient temperature: 25°C

The light source contained in this luminaire shall only be replaced by the manufacturer or his service agent or a similar qualified person

The Roll & Hill Pendant 02 | INSTALLATION

Cord length adjustment

Note: Please contact a licensed electrician.

Example fixture only:

To measure length of stem, first determine overall length (OAL), subtract 2.8" for the canopy height and subtract the fixture height from the OAL. Fixture height is measured from bottom of the fixture to stem connection point. The resulting measurement is the final stem length.

Ex. The fixture below has an OAL of 40" and a fixture height of 11".
 $40'' \text{ OAL} - 2.8'' \text{ canopy} - 11'' \text{ fixture height} = 26.2'' \text{ Stem}$

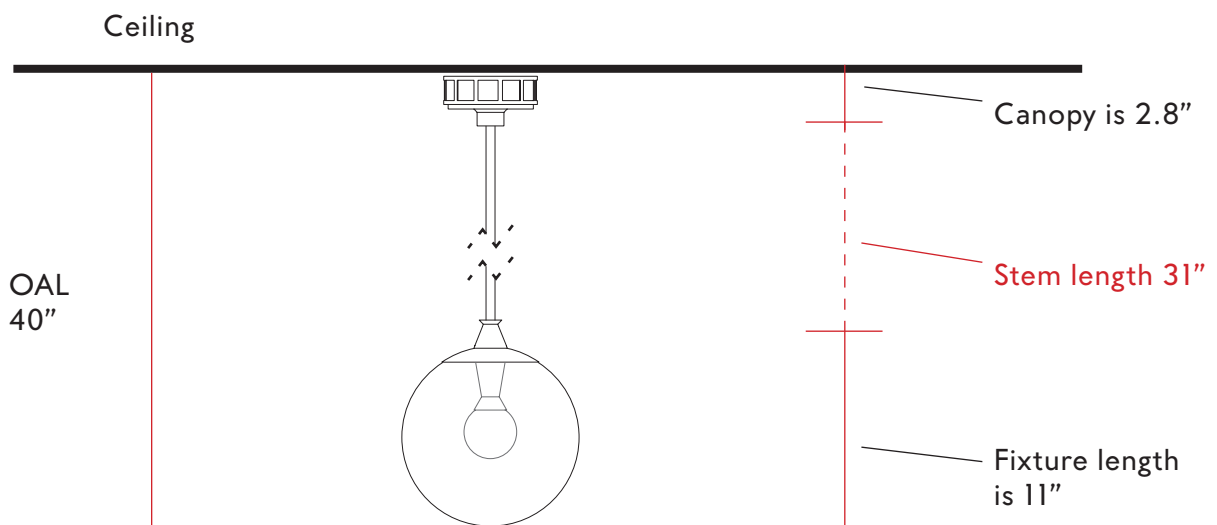

The Roll & Hill Pendant 02 | INSTALLATION

Stem and cover tube length adjustment

Note: Please contact a licensed electrician.

Example fixture only:

1. To customize the length of the provided stem, cut cover tube to desired length. Then cut the inner threaded tube so that it remains $3/4"$ longer than the cover tube.

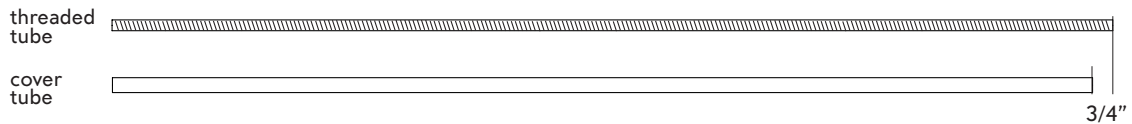

2. Mark the length of the tube required, using a marker or tape. Then hold down the tube with a hand or a clamp, use a hacksaw or electrical tool to cut the tube. Recommended to clean tube after cutting to remove any metal chippings.

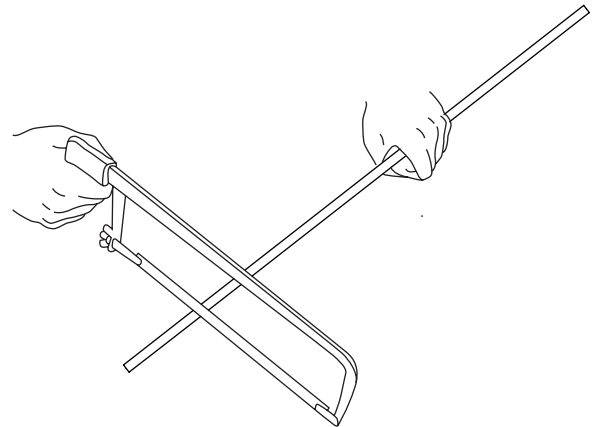

3. Now that the cover tube is cut to $31"$, measure the all thread tube to be 31 and $3/4"$ long. And place a mark, with a marker or tape.

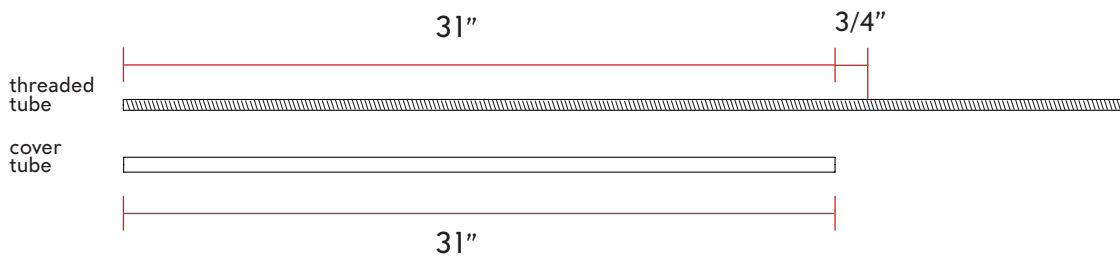

4. Hold down the all thread with a hand or a clamp, use a hacksaw or electrical tool to cut the all thread tube. Recommended to clean all thread tube after cutting to remove any metal chippings.

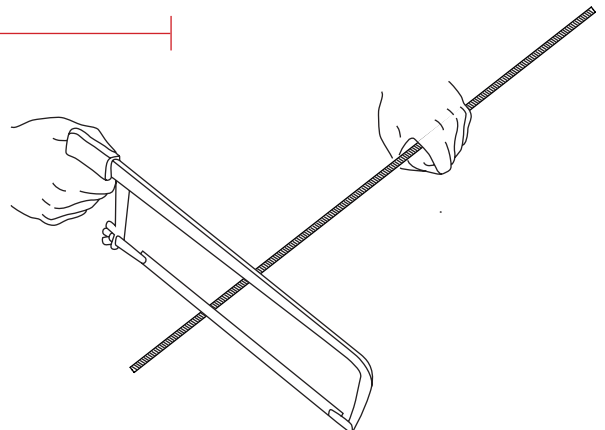

The Roll & Hill Pendant 02 | INSTALLATION

Note: Please contact a licensed electrician for installation. Ensure power is off during installation.

01. Unscrew the canopy nut (A) from the canopy (B), to release the crossbar assembly (C).

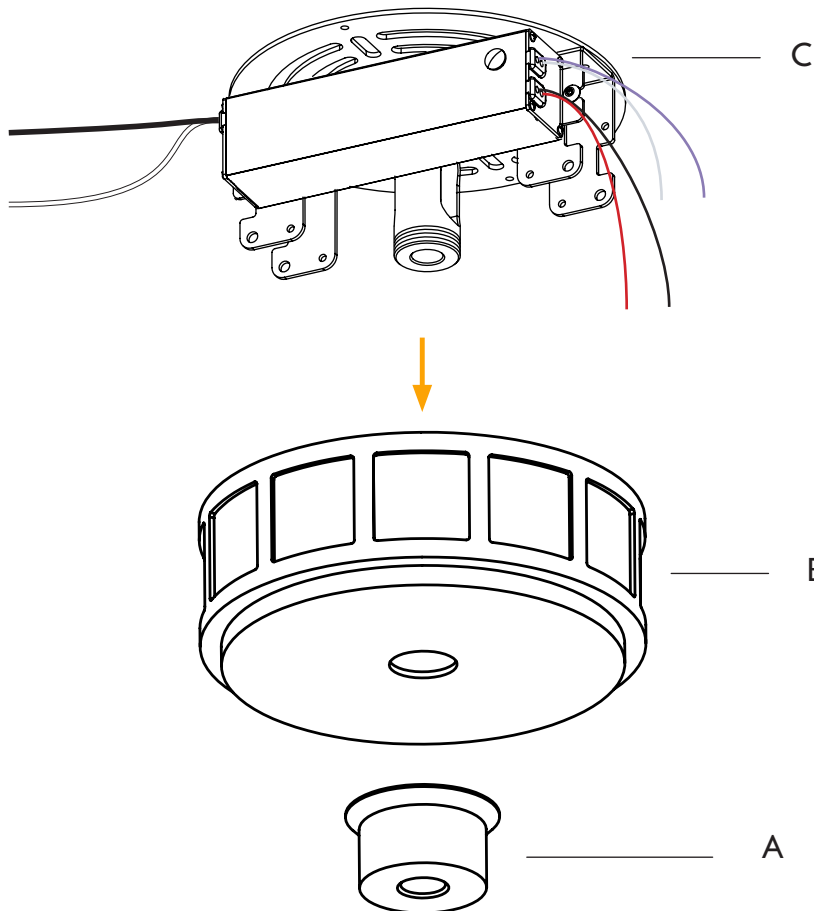

The Roll & Hill Pendant 02 | INSTALLATION

Note: Please contact a licensed electrician for installation. Ensure power is off during installation.

02. After cutting the stem to desired OAL, Screw in the threaded rod (D) into the fixture nut (E)
03. Then slide the cover tube (F) on to the threaded rod, followed by canopy nut (A) and canopy (B).
Be sure to pull the wires through the threaded rod.

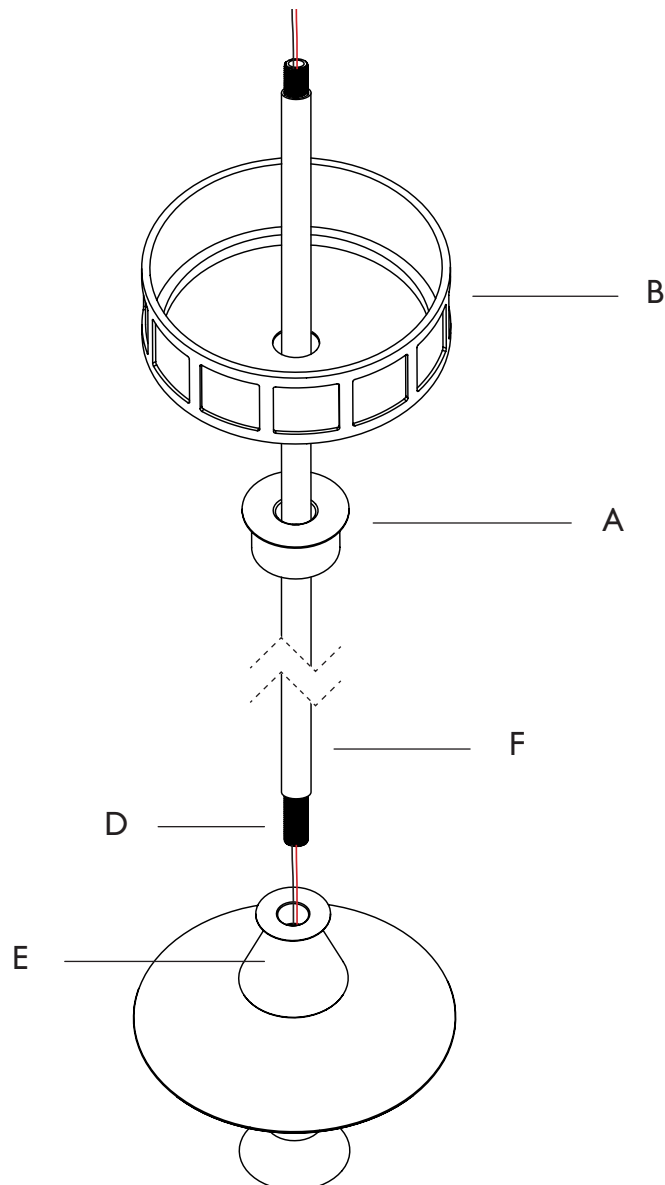

The Roll & Hill Pendant 02 | INSTALLATION

Note: Please contact a licensed electrician for installation. Ensure power is off during installation.

04. Connect the threaded rod (D) to the hickey (G).
Be sure to pull the wires through the hickey.
Do Not connect the wires yet.
05. Attach the crossbar (C) to the J-box (H),
and secure it with two 8-32 screws (I).
Be sure to pull the lead wires from J-box
through the crossbar.
06. Connect the ground wire (J) with the
provided 2-port wago.
07. Connect the secondary wires (K) with the
provided 2-port wgos.
08. Connect the lead wires (L) with the provided
2-port wgos.
09. Optional: connect the dimming wires (M)
with the provided 2-port wagos.

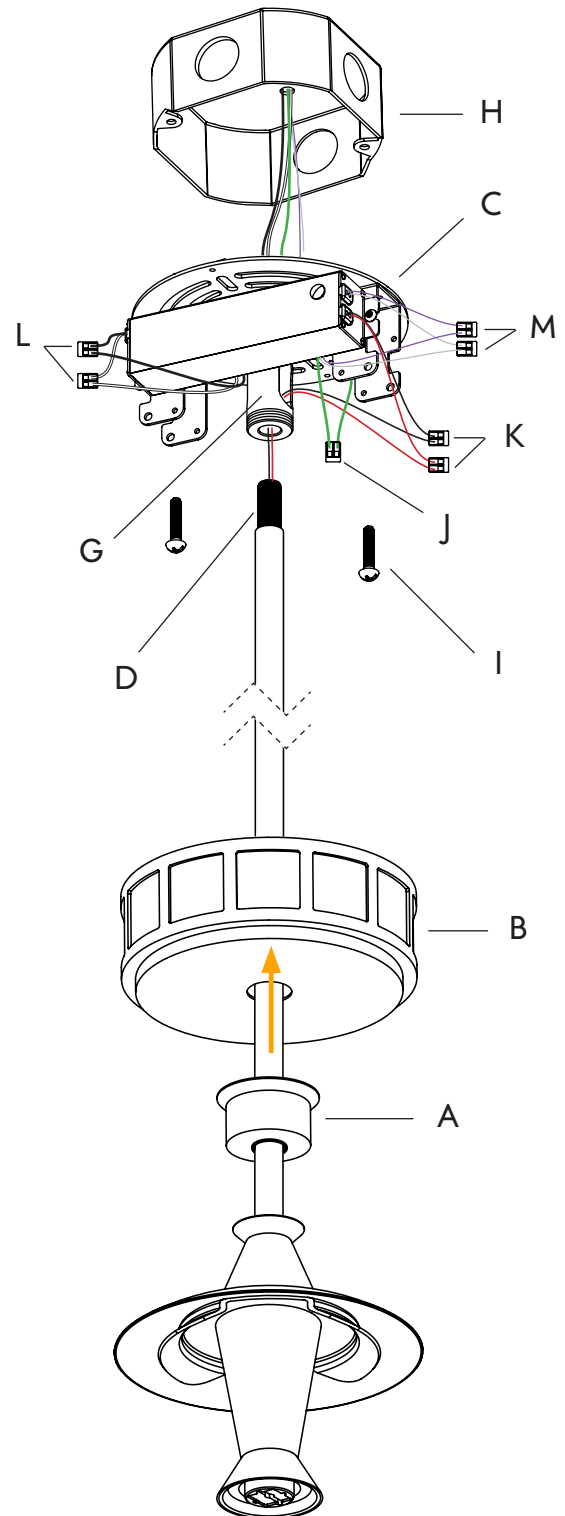

10. After all wires are connected, raise the
canopy (B) over the crossbar assembly (C).
Tuck in all the wires inside the canopy,
and secure it with a canopy nut (A).

The Roll & Hill Pendant 02 | GLASS INSTALLATION

Note: Please contact a licensed electrician for installation. Ensure power is off during installation.

01. Screw in the glass diffuser (A) onto the LED base (B) in a clockwise direction.

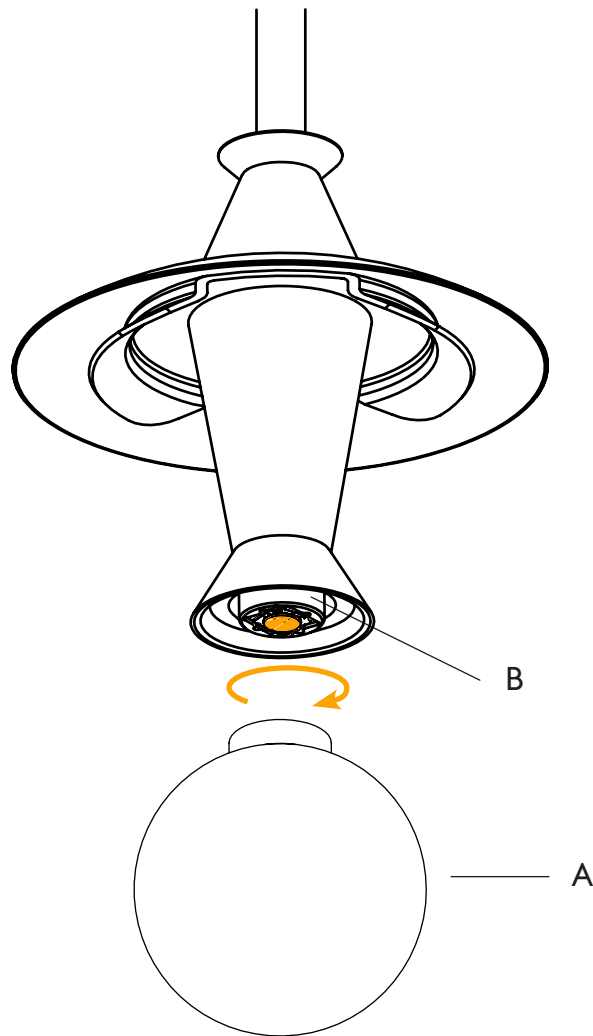

The Roll & Hill Pendant 02 | GLASS INSTALLATION

Note: Please contact a licensed electrician for installation. Ensure power is off during installation.

02. Loosen the fixture nut (C) to raise the glass cap (D).
03. Fit the glass (E) on to the glass fitter (F).
04. Once the glass (E) is resting evenly on the glass fitter (F), clamp down the glass cap (D) and secure it with fixture nut (C).

