

## CONTENTS

### Seed 04 Chandelier

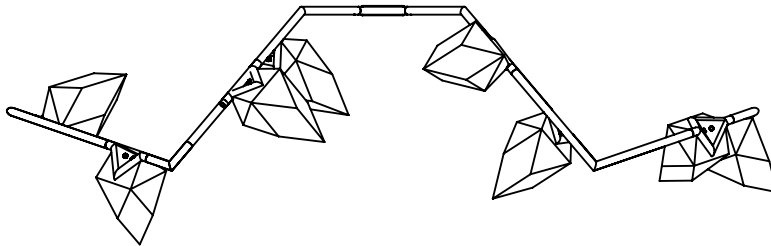

### Crossbar

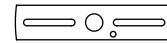

### 8-32 Screws (2)



### Threaded Tube and Cover Tube



### Bulbs (8)

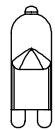

20 -Watt G9  
Halogen

### Glass Screws (16)



### Hangstraight



### Seed Glass (8)

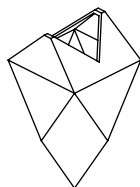

### Canopy

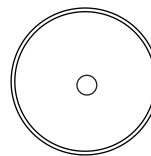

### 1/4 IPS Nipple



## SAFETY INFORMATION

Only one light bulb per socket.

Only suitable for direct mounting on non-combustible surfaces.

Under no circumstances can Seed Fixtures be mounted on normally flammable surfaces.

Suitable for dry, indoor use only.

Maximum ambient temperatures: 25° C

## CEILING INSTALLATION | SEED 02, 03, 04

*Note: Please contact a licensed electrician.*  
*Note: Do not use bulbs that exceed 20 watts.*

1. To customize the length of the provided 36-inch stem, cut cover tube to desired length. Then cut the inner threaded tube so that it remains 1/2" longer than the cover tube.

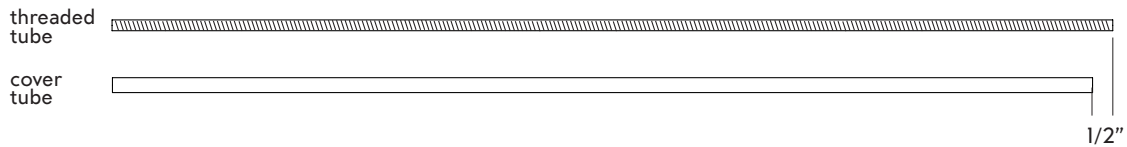

2. Thread one end of the threaded tube about a quarter inch into the top of the fixture. Feed the lead wires through to the top. Then slide the cover tube over the threaded tube.

3. Slide hangstraight nut (E) and canopy (D), open side up, onto cover tube. Leave suspended until step 7.

4. Thread one end of the hangstraight (A) onto the other end of the threaded tube, until cover tube is held tightly in between.

5. Screw 1/4 IPS nipple into other side of hangstraight, and screw crossbar (B) on to nipple.

6. Install crossbar (B) to junction box (C) using provided 8-32 machine screws.

7. Make lead wire connections (F) and tuck into junction box.

8. Raise the canopy and the hang-straight nut to the ceiling. Thread the nut onto the hang-straight, tightening the canopy flush to the ceiling.

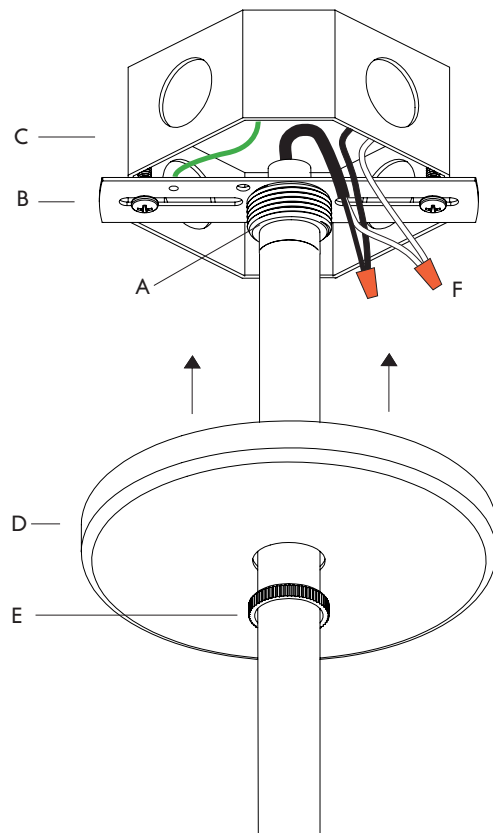

## INSTALLATION | ATTACHING SEED GLASS

---

*Note: Please contact a licensed electrician.*

*Note: Do not use bulbs that exceed 20 watts.*

1. Carefully position seed glass on frame. Attach by gently tightening provided thumb screws through two holes in frame to the threaded glass insert. Make sure glass is secure before releasing.
2. To replace halogen bulbs, support glass and remove two thumb screws. Pull bulb out of socket and replace by pushing replacement in. Repeat step 1 to replace seed glass.

