

CONTENTS

17DEC2019

Pole 02 Base
 (x1 powered & x1 non-powered)

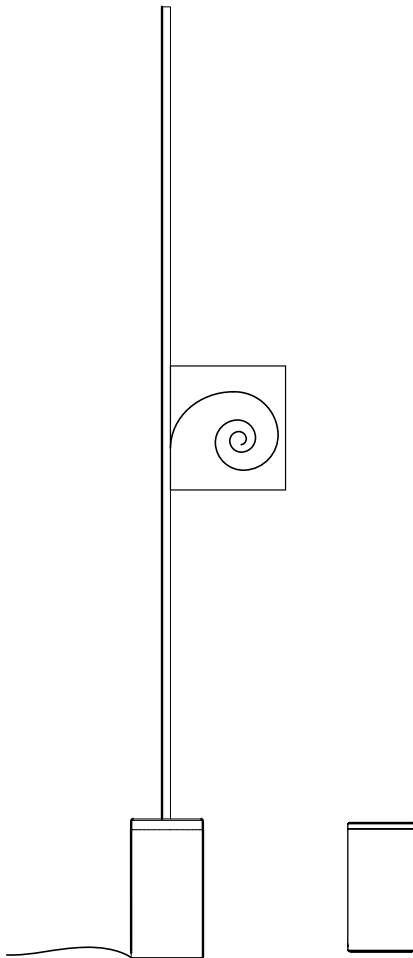

Pole Extrusion (see table) - One Labeled "Large Base"

Pole Fitter (see table)



# of Sections	# of Extrusions	# of Fitters
4	4	3
5	5	4
6	6	5
7	7	6
8	8	7

1x 7/64" Hex Driver

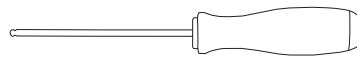

1x 5/64" Hex Driver

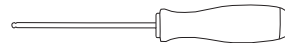

1x Seam Roller

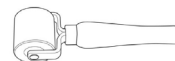

Power Adapter Plugs (AU, UK, EU, US)

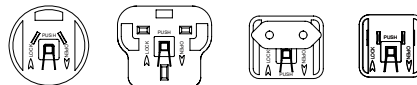

SAFETY INFORMATION

Only suitable for direct mounting on non-combustible surfaces.
 Under no circumstances can Pole fixtures be mounted on normally flammable surfaces.
 Suitable for dry, indoor use only.
 Maximum ambient temperatures: 25° C

Note: Please contact a licensed electrician for installation.

1. Carefully lay the powered Pole base (A) on it's side. Lay all the extrusions end to end. Make sure the extrusion marked "Large Base" is last and that the drilled hole is at the very end.

Be sure to lift up from the heavy metal base (A) and not from the thin extrusion (B). These bases are appx. 35lbs/15kg each so make sure to lift carefully.

2. Connect the extrusions together using the provided fitters (C). A rubber mallet may be cautiously used to force the fitter in the extrusion.

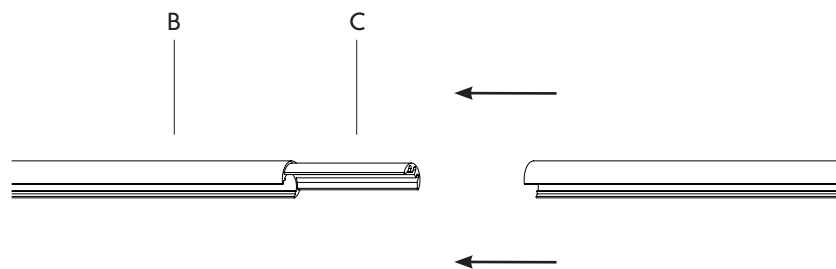

⚠ USE RUBBER Mallet ONLY ⚠
PROCEED WITH CAUTION

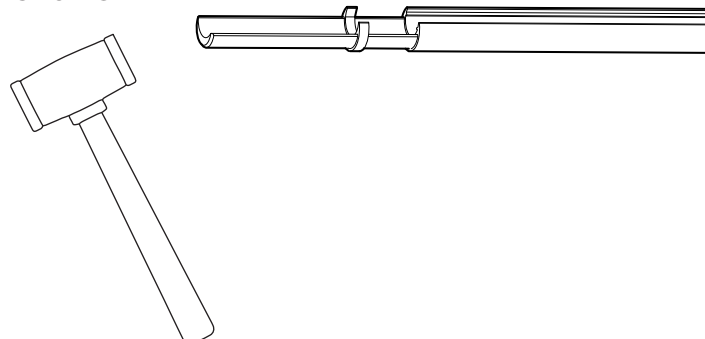

Note: Please contact a licensed electrician for installation.

3. Plug in the fixture to test the LED tape (D) (See Power Adapter Installation section). While the tape is still on and starting from the powered base end, gently feed the tape in the extrusion using the roller (E). To achieve best result, roll one side of the tape first, then proceed with the other. Leave the plug in during the entire process, this will help to prevent any visible waves and irregularities during the tape feeding step. Unplug the fixture once the operation is complete.

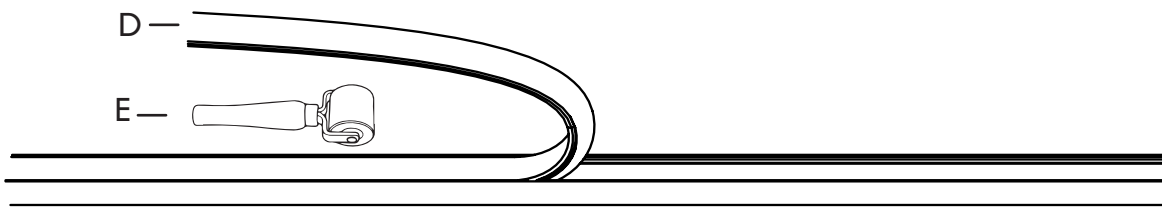

Note: Please contact a licensed electrician for installation.

4. With the fixture unplugged, use a pair of sharp scissors and cut the extra LED tape so it is flush with the metal extrusion. Replug the fixture to check the result. After cutting, a small amount of light may be lost at the end tip.

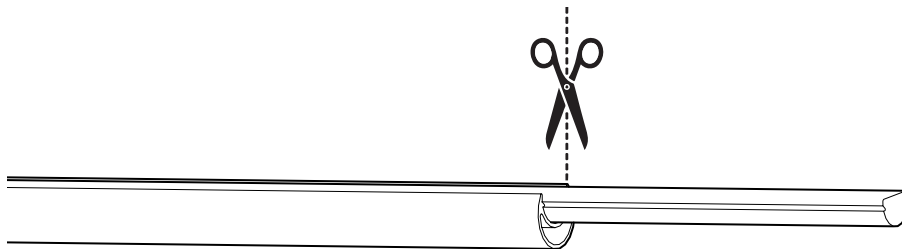

Note: Please contact a licensed electrician for installation.

5. Remove the coverplate (F) from the unpowered base by removing the set screw (G) using the provided hex driver.

6. Feed the end of the extrusion through the opening on the top of the cover plate. Slide the coverplate up until the bump on the clamp (H) meets the hole in the extrusion.

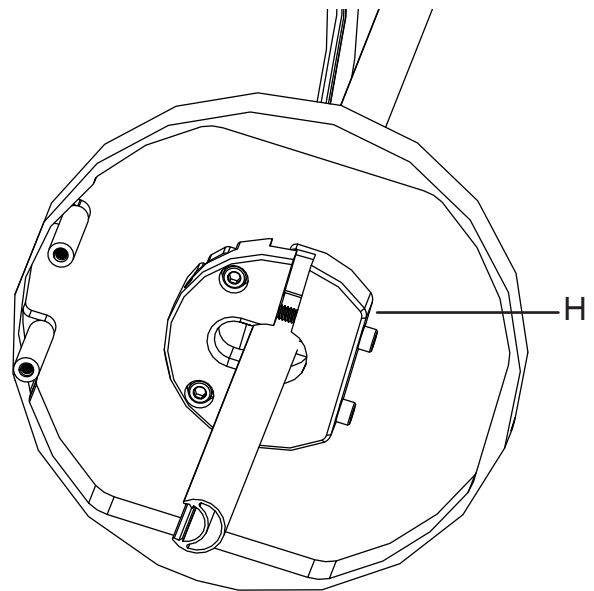
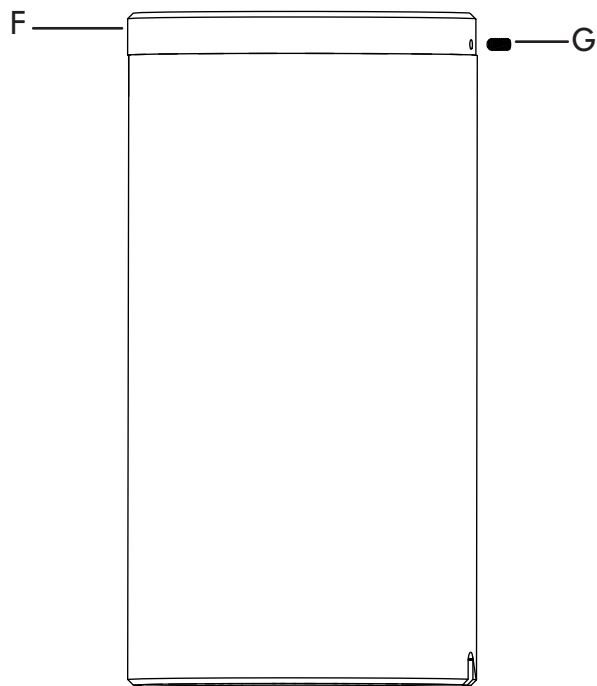

Note: Please contact a licensed electrician for installation.

7. With the bump on the clamp secured over the drilled hole in the extrusion, tighten the clamp (H) using the hex driver provided.

8. Carefully lay the unpowered base (A) on its side, and slide the coverplate (F) into place. Once in place, secure with the setscrew (I).

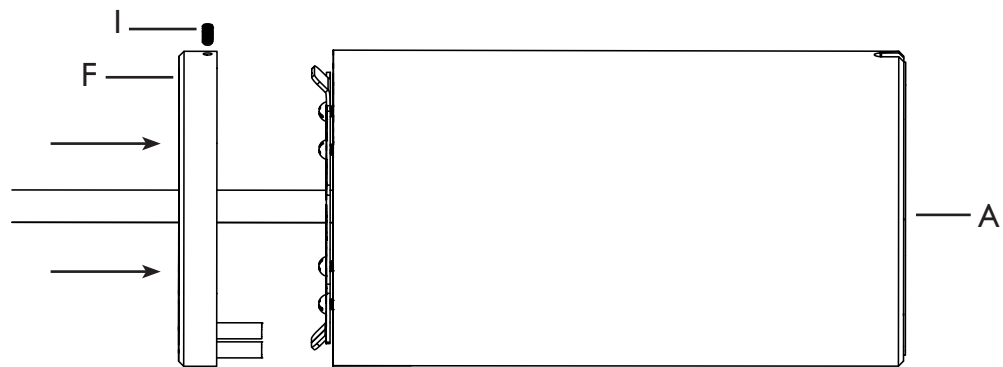
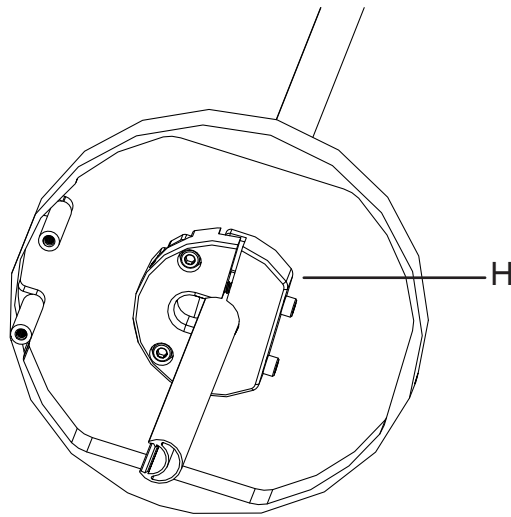

POLE 02 | INSTALLATION

Note: Please contact a licensed electrician for installation.

Note: Ensure power is off during installation.

9. This step requires 2 people. Pick up each Pole base and slowly bring them towards each other, causing the extrusions to flex into a half circle. Refer to the spec sheet for the recommended spacing.

*! \ Do not vary from this recommended spacing ! *

Be sure to pick them up from the heavy metal base (A) and not from the thin extrusion (B). These bases are appx. 35lbs/15kg each so make sure to lift carefully.

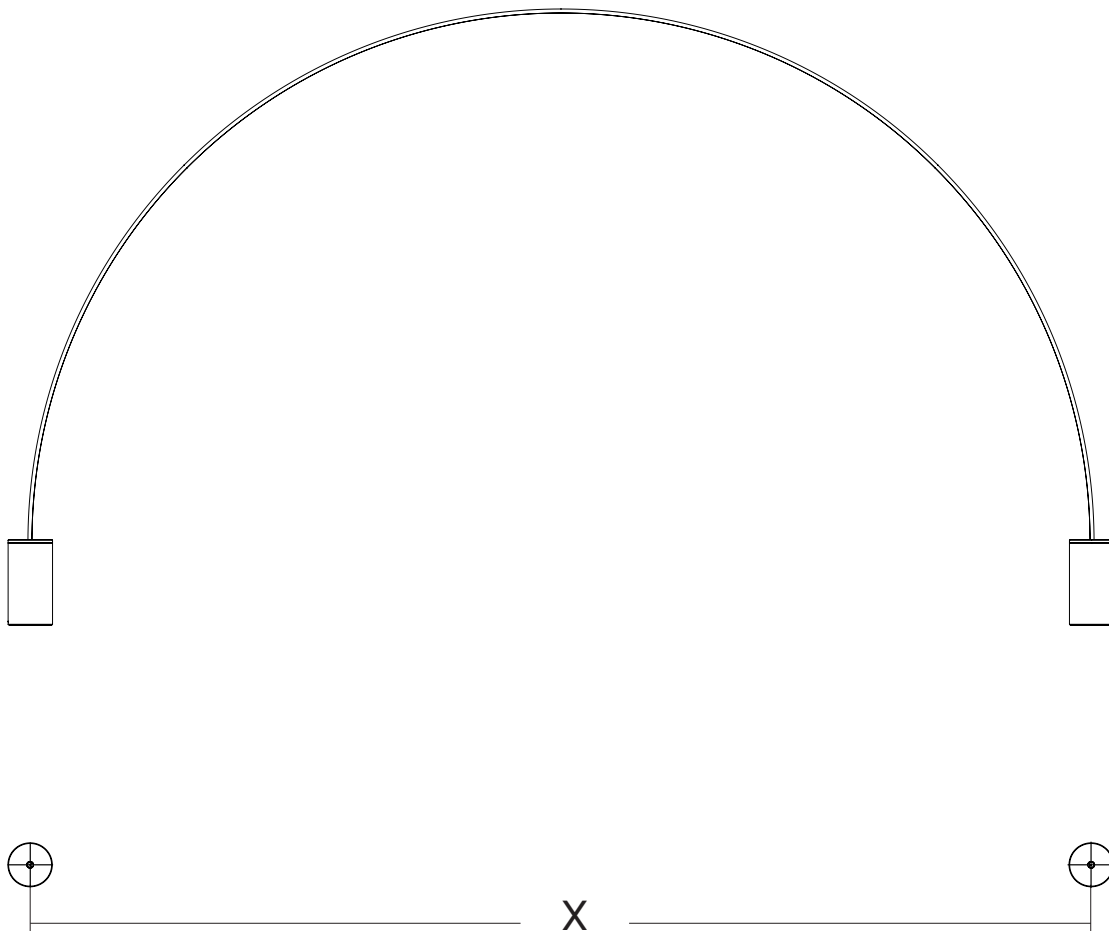

POLE 02 | Power Adaptor Installation

1. Find the suitable driver adaptor for your country's outlet type.



North America



Europe

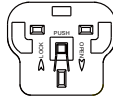

United Kingdom



Australia

2. Slide driver adaptor (A) into USB driver (B) until it clicks into place.

3. To remove a driver adaptor, press on the flexible tab on the adaptor (A) and slide it out of the USB driver (B).

