

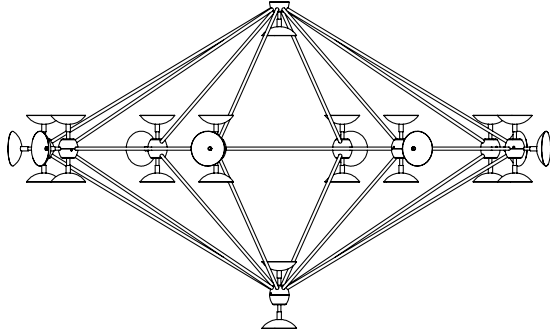

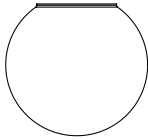



CONTENTS

<p>Modo 8 Sided - 27 Globes</p> 		<p>Globes (27)</p> 	<p>Stem and Top Hub</p> 
<p>8-32 Screws (2)</p> 	<p>6-32 Socket Screws (2)</p> 	<p>Crossbar</p> 	
<p>Bulbs (27)</p>  <p>Incandescent 120V (bulbs included) Incandescent 240V (bulbs not included)</p>	<p>7-64 Allen Key</p> 	<p>Canopy</p> 	

SAFETY INFORMATION

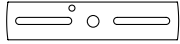
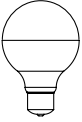
Only one light bulb per socket.
 Only suitable for direct mounting on non-combustible surfaces.
 Under no circumstances can Modos Chandeliers be mounted on normally flammable surfaces.
 Suitable for dry, indoor use only.
 Maximum ambient temperatures: 25° C

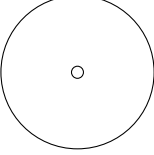
CEILING INSTALLATION | MODO

*Note: Please contact a licensed electrician.
Note: Do not use bulbs that exceed 25 watts.*

1. To customize the length of the provided 36-inch stem, cut cover tube to desired length. Then cut the inner threaded tube so that it remains 1/2" longer than the cover tube.

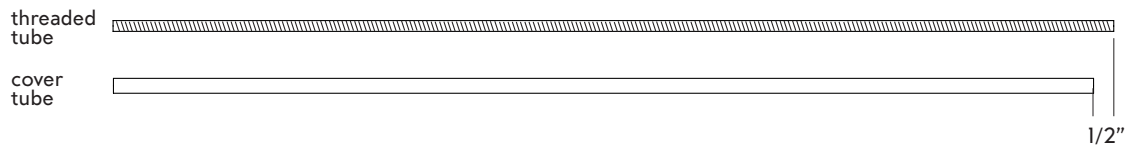

2. Install the crossbar (A) using #8-32 screws to junction box (B) in ceiling.

3. Attach the green ground wire to the crossbar with ground screw (C).

4. Once the crossbar is secure, screw the threaded inner tube (D) a quarter inch into the center hole. Feed the wires from the bottom of the threaded tube into the junction box, strip wires, and make electrical connections.

5. Conceal wires and connections inside junction box.

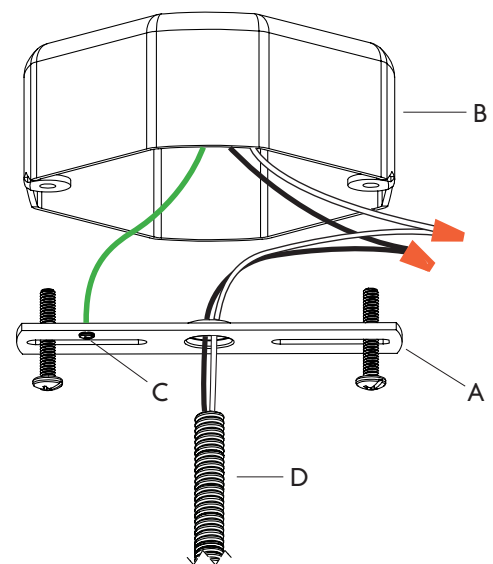

CEILING INSTALLATION | MODO

6. Slide the canopy (E) up the threaded tube to the ceiling, followed by the cover tube (F).

7. Screw the half hub (G) onto the bottom of the all-thread rod. This will tighten the canopy flush to the ceiling.

8. Carefully lift the fixture so that the two half-hubs align. Cut excess wire, strip ends, and make electrical connections between the stem and the fixture (H). Tuck wire nuts and wires inside the hub and close.

Note: This step requires two people.

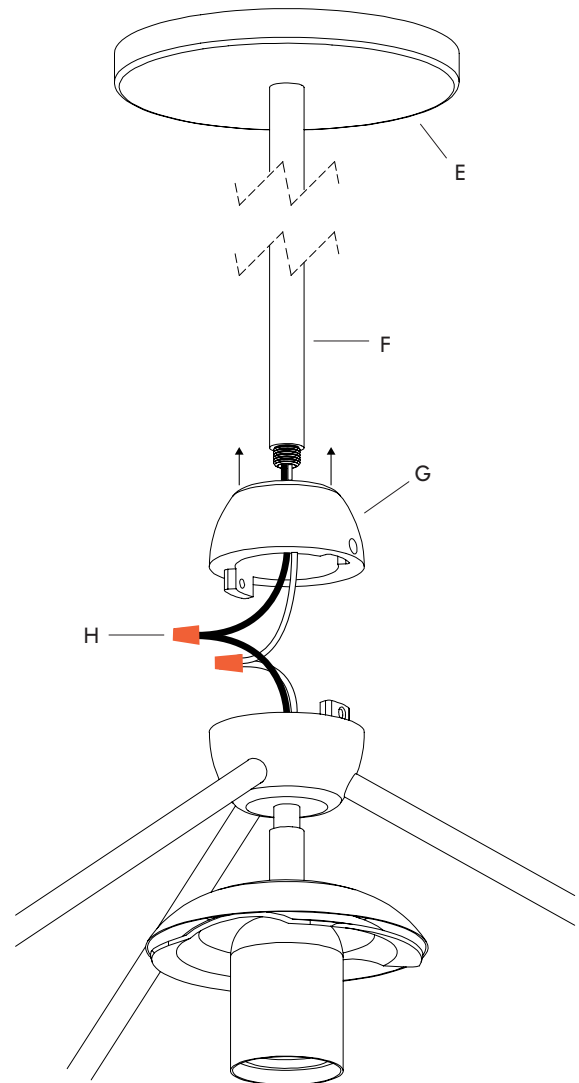

9. Secure the two half hubs together using a hex key and the provided #6-32 socket screws on either side.

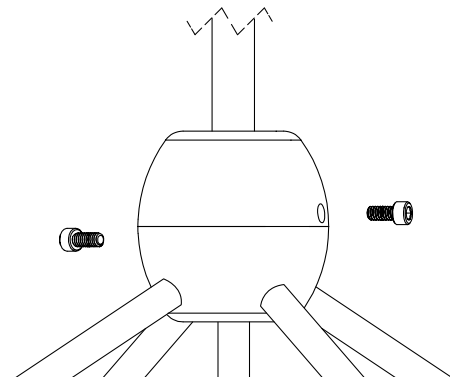

INSTALLATION | ATTACHING MODO GLOBES

Note: Make sure to power off fixture before changing bulbs.

1. Screw light bulbs into sockets. Sandwich the glass globe (A) around the socket fitter (B) and cap (C). Gently tighten the sleeve (D) to hold the globe in place.

