

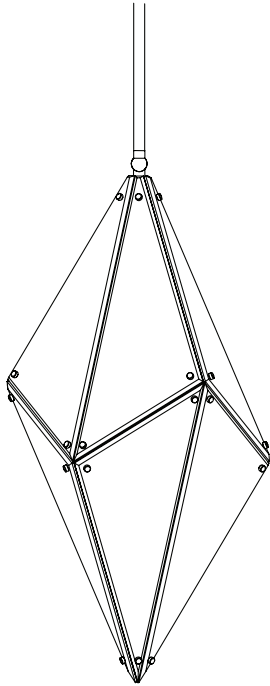





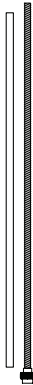

CONTENTS

<p>Maxhedron Vertical 24in, 30in, 42in</p> 	<p>Crossbar 1/8 IPS</p> 	<p>Cover Tube / Threaded Rod & Hangstraight</p> 
	<p>8-32 Screws (2)</p> 	<p>Canopy and Transformer</p> 
<p>Suction Cup</p> 	<p>Extra Halogen Bulbs (2)</p>  <p>Halogen 120V (bulbs included) Halogen 240V (bulbs not included)</p>	<p>Threaded 1/8 IPS Nipple</p> 
		<p>Cleaning Cloth</p> 

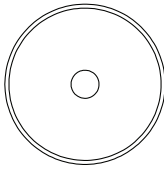
SAFETY INFORMATION

- Only one light bulb per socket.
- Only suitable for direct mounting on non-combustible surfaces.
- Under no circumstances can Maxhedron be mounted on normally flammable surfaces.
- Suitable for dry, indoor use only.
- Maximum ambient temperatures: 25° C

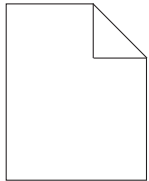
MAXHEDRON | CEILING INSTALLATION

Note: Please contact a licensed electrician.
Note: Do not use bulbs that exceed 20 watts.

1. To customize the length of the provided 36-inch stem, cut cover tube to desired length. Then cut the inner threaded tube so that it remains 1/2" longer than the cover tube.

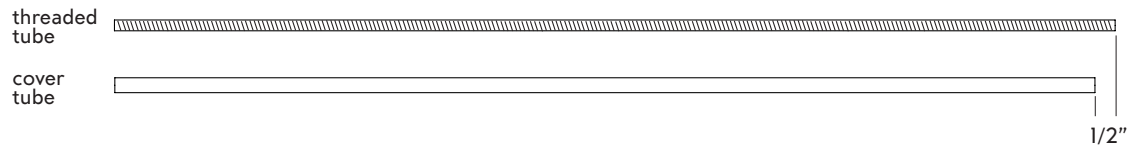

1. Install the crossbar (B) using #8-32 screws to junction box (A). It is recommended to make the wire connections after installing the crossbar.

2. Once the crossbar is secure, tuck the connected wires into the junction box and raise the canopy (C) and the hang-straight nut (D). Thread the nut onto the hang-straight, tightening the canopy flush to the ceiling.

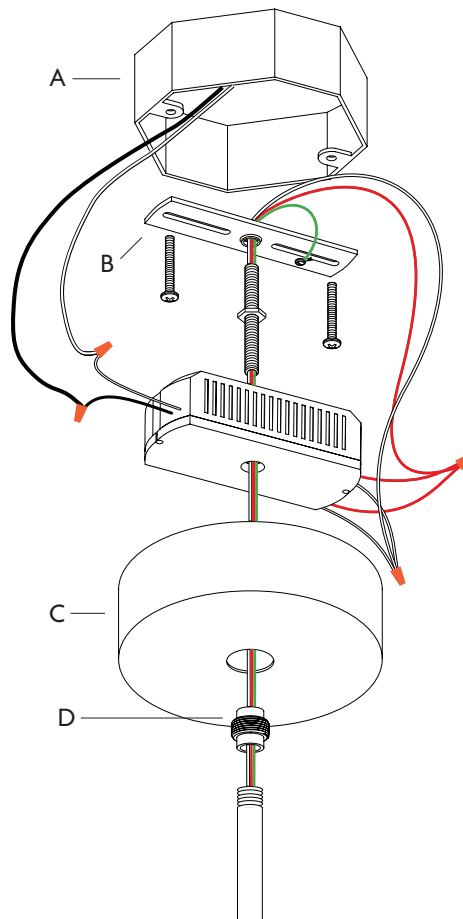

MAXHEDRON | REPLACING BULBS (VERTICAL)

Note: Make sure to power off fixture and allow bulbs and metal arms to cool.

Note: Do not touch bulbs with bare hands.

Note: Do not unscrew top four glass panels.

Note: Only replace with 12 VAC, 20 W G4 BI-PIN Halogen or xenon bulbs

To replace the Halogen bulbs in your Maxhedron lighting fixture, remove one of the panels (A) of glass by unscrewing the three thumbscrews (B) holding it in place. (Note: Only remove one panel at a time.) Carefully brace the panel while loosening the screws. If necessary, use suction cup to stabilize. Remove the halogen bulb (C) by pulling it straight out and replace by pushing in gently. Reattach the glass panel by carefully tightening the thumbscrews. Always make sure silicone pads remain on the inside and nylon washers remain on the outside of the glass.

