

CONTENTS

Halo - 4 Rings

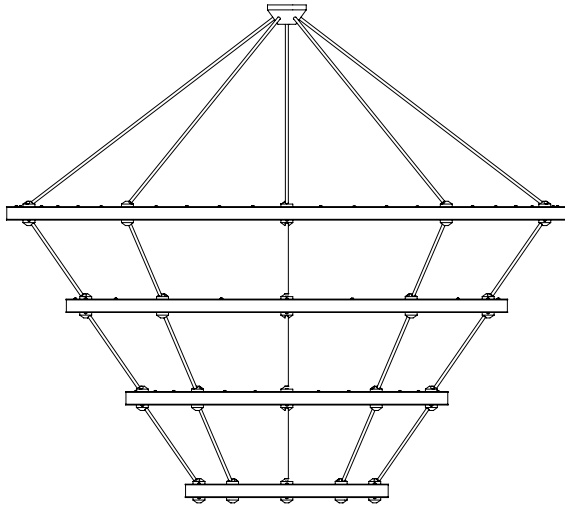

Stem with 1/4 IPS Threaded Rod
& Hangstraight



Canopy Assembly

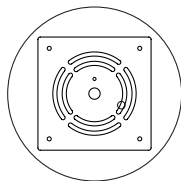

8-32 Crossbar
Screws (2)



SAFETY INFORMATION

Only suitable for direct mounting on non-combustible surfaces.
Under no circumstances can Halo Chandeliers be mounted on normally flammable surfaces.
Suitable for dry, indoor use only.
Maximum ambient temperatures: 25° C

HALO | CEILING INSTALLATION

Note: Please contact a licensed electrician.

1. To customize the length of the provided 36-inch stem, cut cover tube to desired length. Then cut the inner threaded tube so that it remains 1/2" longer than the cover tube.

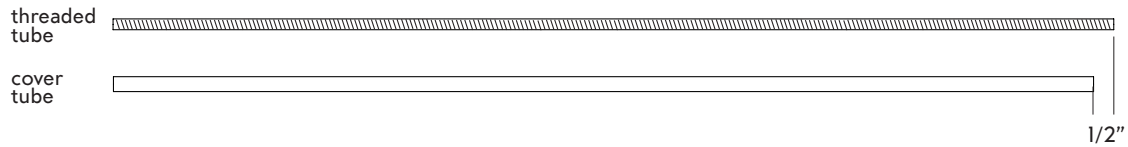

2. Detach crossbar (A) from assembly by unscrewing bottom standoff screws (B).

3. Install the crossbar using #8-32 screws to junction box (C) in ceiling. Pull the lead wires through the center hole in order to make lead connections.

4. Attach the green ground wire to the crossbar with ground screw (D).

5. Make wire connections between junction box leads and the voltage transformer (E).

6. Slide hangstraight nut (F) and canopy (G) down cover tube and screw inner threaded tube into hangstraight (H).

7. Feed fixture lead wires from the driver assembly down through the cover tube (I).

6. Raise canopy and hangstraight nut to ceiling and tighten nut around hangstraight. This will tighten canopy flush to ceiling. Make sure to conceal wires and connections inside canopy.

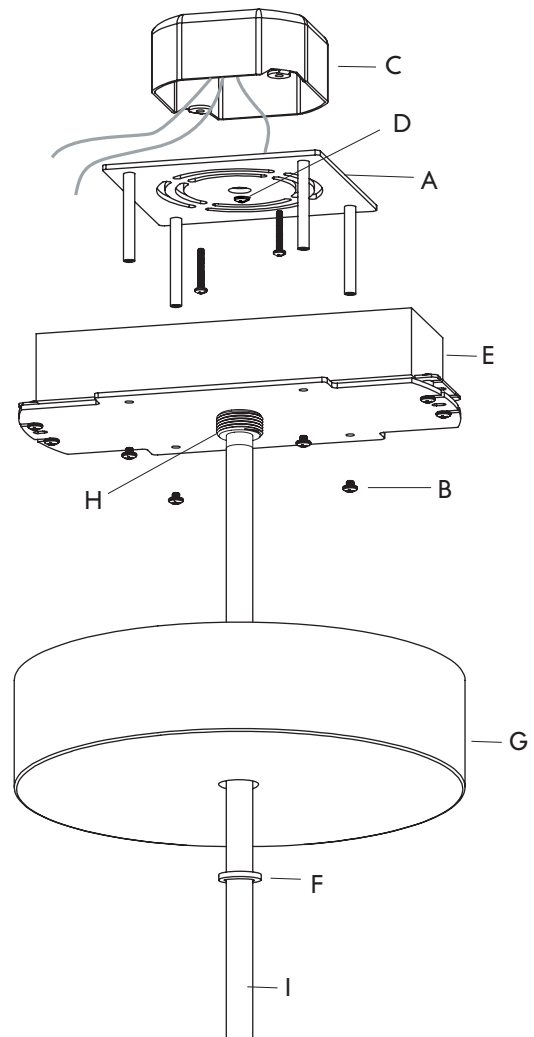

HALO | CEILING INSTALLATION

Note: This step requires two people.

6. Separate hub (G) and hub cap (H) by removing five machine screws. Run wires through threaded stem and cover tube and attach to canopy.

7. Carefully lift the fixture so that the hub and cap align. Cut excess wire, strip ends, and make electrical connections between the stem and the fixture. Tuck wire nuts and wires inside the hub and close.

8. Secure the plate and hub back together using same five machine screws.

