

CONTENTS

Cross 1 (Parts A & B)

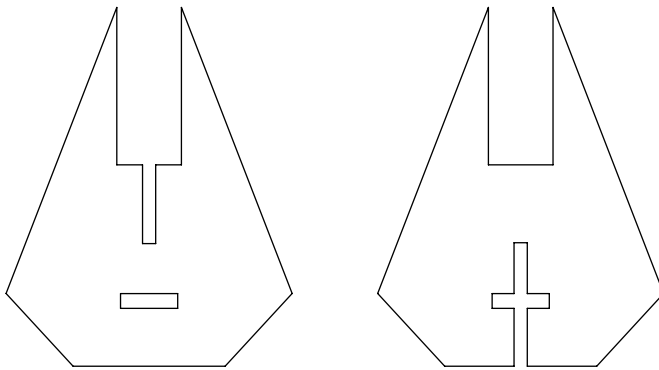

Candlestick



Leather Tab (2)



SAFETY INFORMATION

Only suitable for direct mounting on non-combustible surfaces.
Under no circumstances can Cross Fixtures be mounted on normally flammable surfaces.
Suitable for dry, indoor use only.
Maximum ambient temperatures: 25° C

CROSS ASSEMBLY

1. Vertically slide piece A onto piece B where cut-outs are aligned.

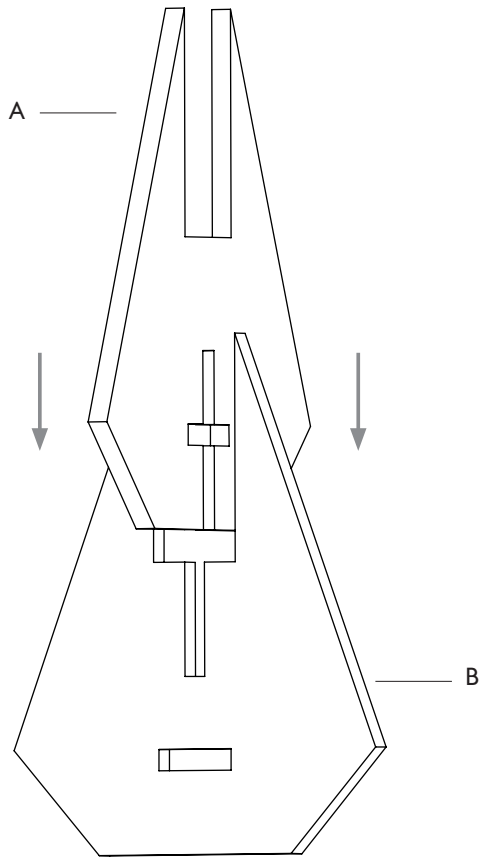

2. To secure together, slide leather tabs C and D through cut-out, one on top of the other.

3. Place provided candle into opening.

