

## CONTENTS

Updated 18SEPT2019

(x1) Lighting Assembly

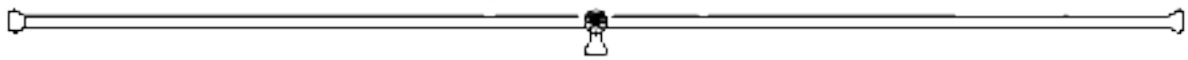

<p>(x2) Threaded tube</p>	<p>(x2) Cover tube</p>	<p>(x1) Canopy</p>			
		<p>(x1) Crossbar assembly</p>		<p>(x2) Hang-straight</p>	
		<p>(x5) Glass</p>	<p>(x5) LED Bulbs</p>	<p>(x2) Fishmouth</p>	<p>(x3) Wago Connector</p>
		<p>(x1) Driver</p>	<p>(x2) Plastic Bushing</p>	<p>(x1) L-Key</p>	<p>(x2) 8-32 Screw</p>
		<p>(x2) Wood screw On 240V fixtures only</p>	<p>(x2) Long 8-32 screw On 240V fixtures only</p>	<p>(x2) Metal screw On 240V fixtures only</p>	<p>(x2) Toggle anchor On 240V fixtures only</p>

## SAFETY INFORMATION

Suitable for damp locations

Maximum ambient temperature: 25°C

CAUTION RISK OF FIRE – MAX 3W TYPE G4 LED self ballasted UL1993/CSAC22.2 no. 1993

## APOLLO | INSTALLATION

*Note: Please contact a licensed electrician for installation. Ensure power is off during installation.*

01. Plug one Plastic Bushing (A) in each of the Threaded tube (B). Feed each Threaded Tube (B) through each Cover tube (C). Thread a hang-straight (D) on top on each Threaded Tube and carefully maneuver its threaded collars (E) and the Wooden Canopy (F) so they slip downward onto the Cover tubes (C).

02. Feed the wires (G) from the Lighting assembly (H) through one of the Fishmouth (I), Stem assembly with Wooden Canopy (A-B-C-D-E-F) and Crossbar assembly (J) as shown below.

03. Secure the assembly by fastening the two threaded tubes (B) to the Crossbar assembly (J), then to the Lighting assembly (H) through the Fishmouths (I).

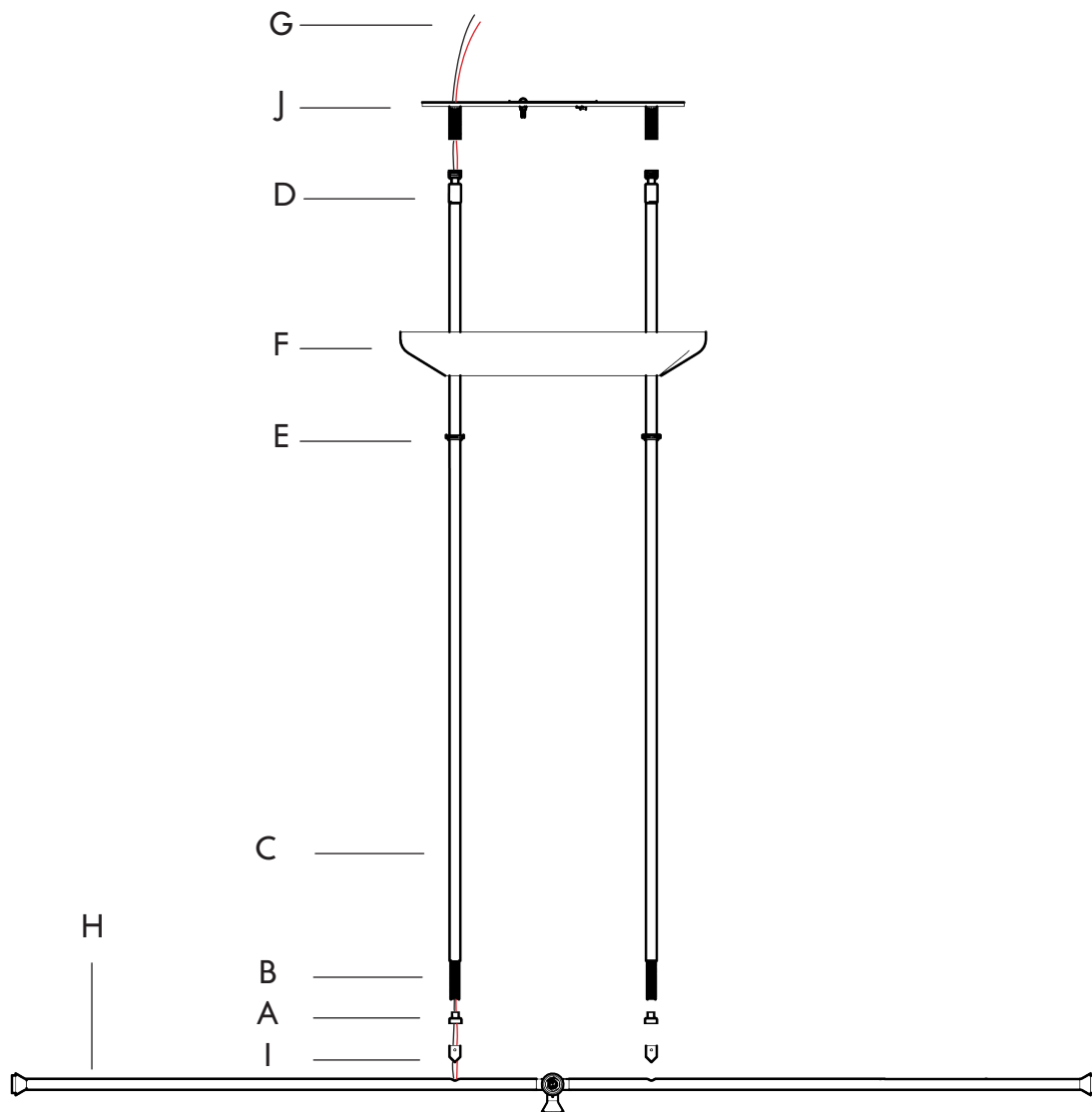

## APOLLO | INSTALLATION

---

04. Place the crossbar assembly (A) against the two rods and hangstraights (B). Thread the rods (C) down onto the hangstraight until it is flush at the top of the mounting bracket. Secure the stems by threading the two nuts (D)

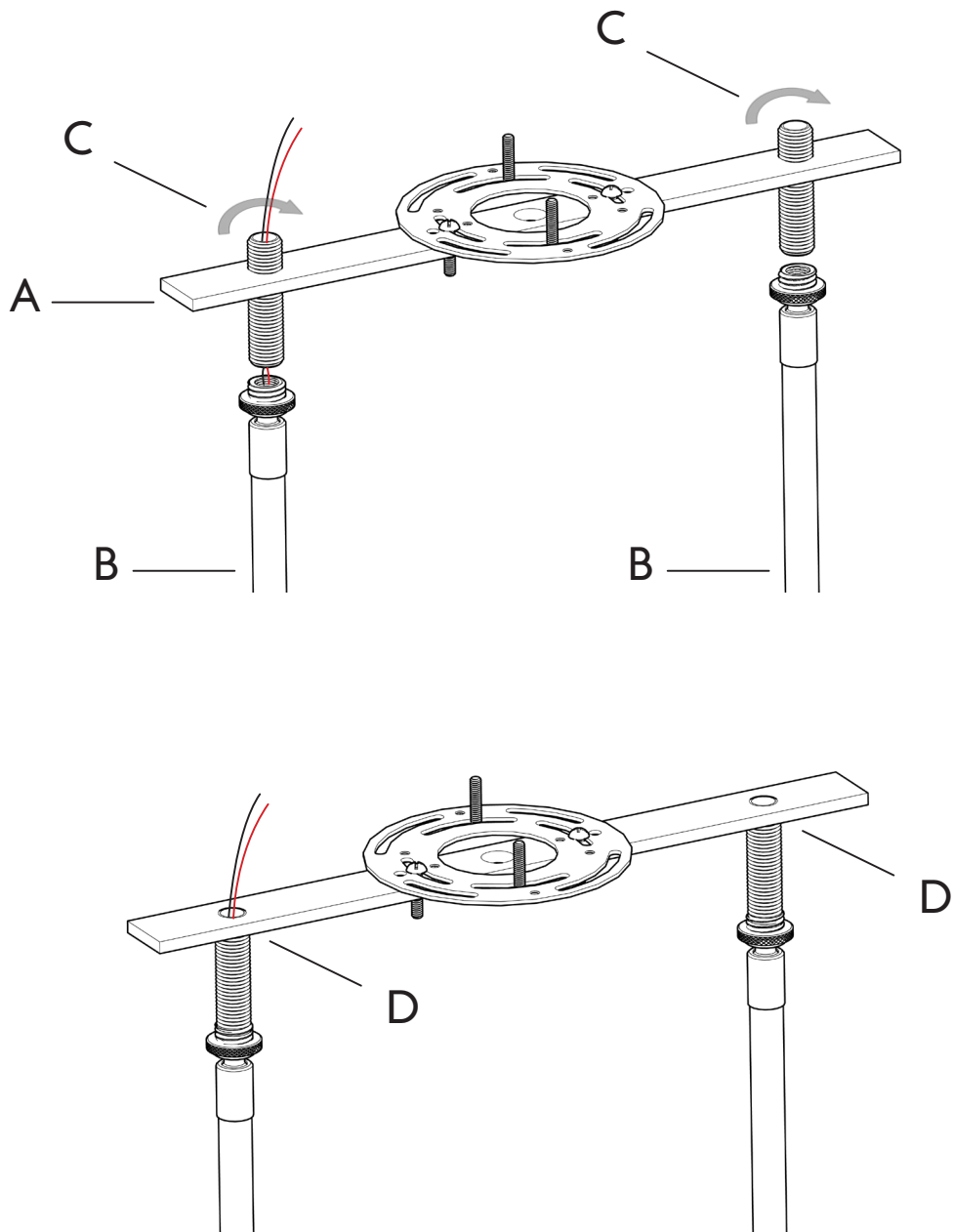

## APOLLO | INSTALLATION

---

04. Gently lower down the wooden canopy (A) through the stems (B) so it can rest. Be careful not to scratch the finish.
05. Once the fixture is assembled, use the provided L Key to tight the bottom set screw on each Fish-mouth (B) to secure the fixture.

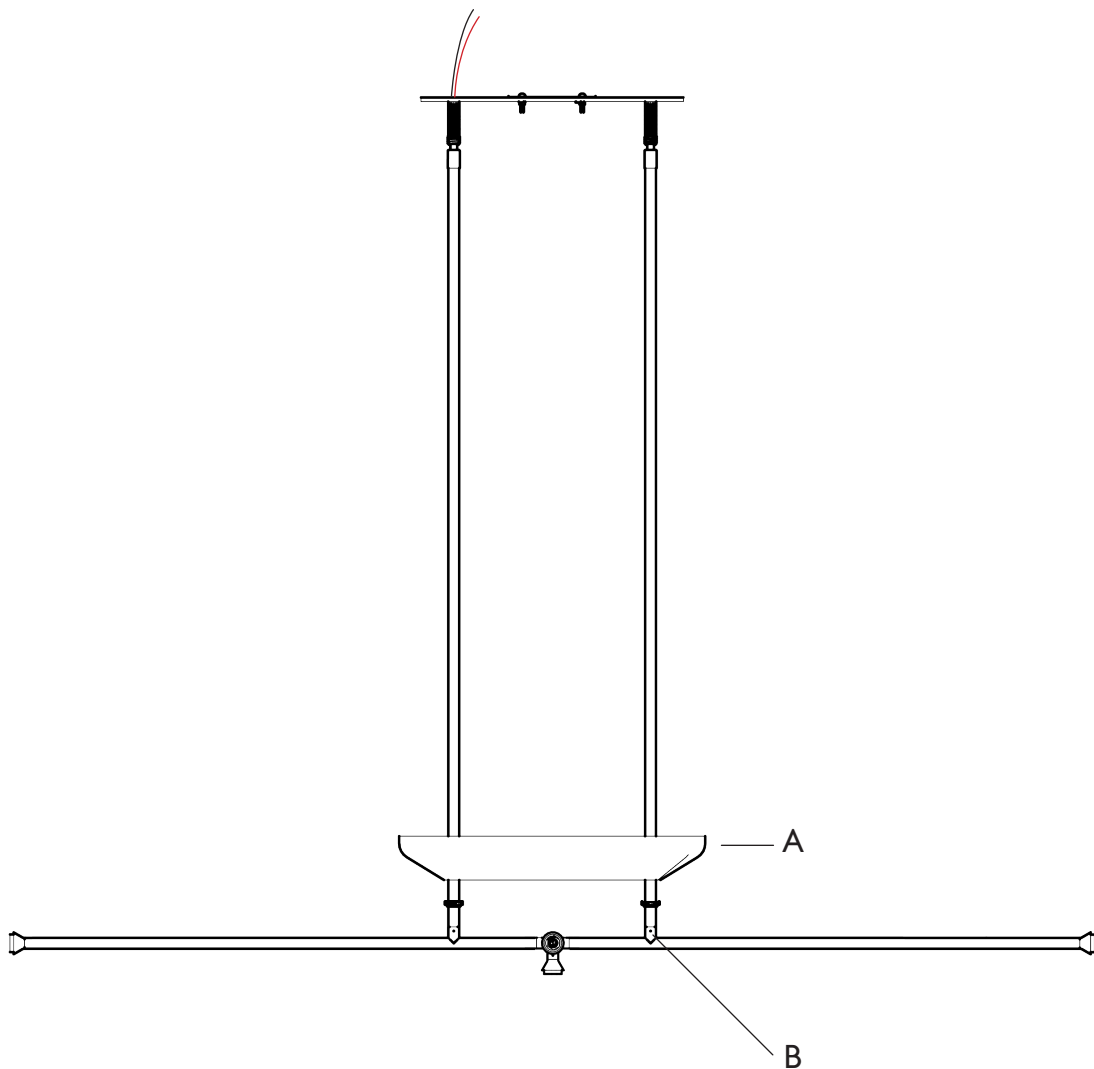

## APOLLO | INSTALLATION

---

06. Make the electrical connections between the lead AC wires and the driver using the provided Wago Connectors (A)  
Once properly wired, nestle the wires and the driver comfortably into the interior liner of junction box.

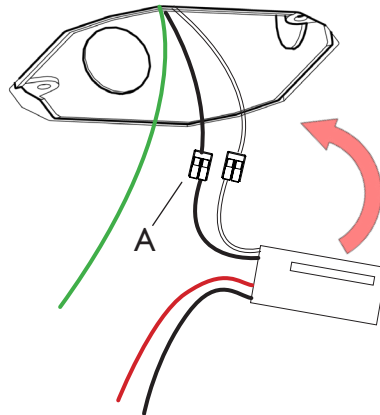

07. Bring the secondary wires and the main ground wire out from the ceiling through the center hole of the crossbar assembly. Connect a Wago Connector to wire. (B)

08. Secure the fixture by threading the provided screws into the ceiling Junction-Box (C)  
240V VERSION: Use the provided Toggle anchors and screws as necessary to secure the fixture to the ceiling.

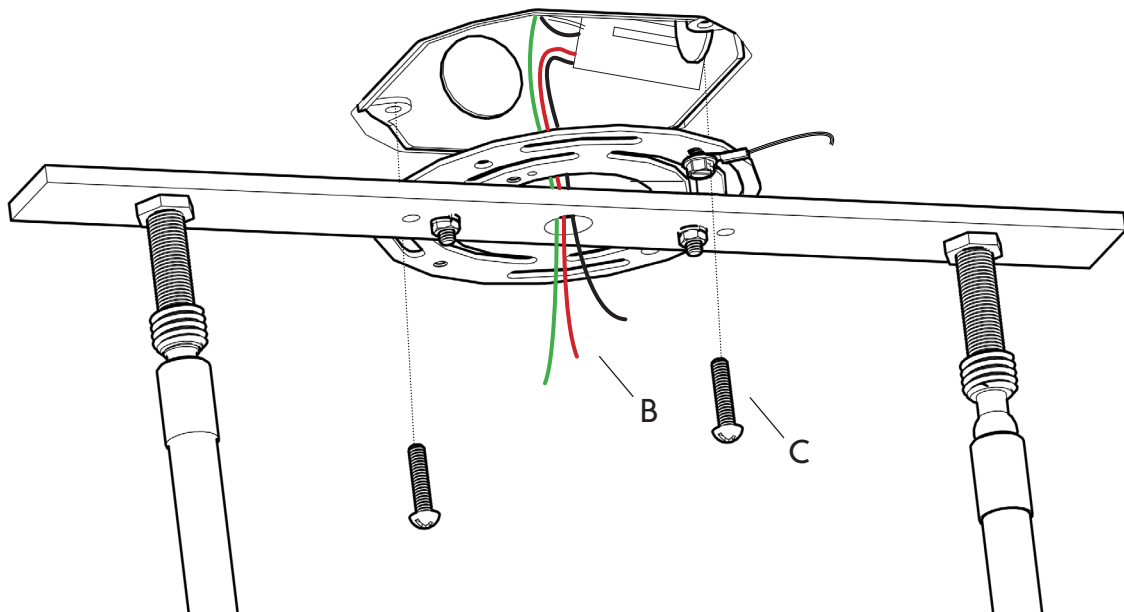

## APOLLO | INSTALLATION

---

09. Connect the ground wire to the fixture's crossbar using the provided Wago Connector (A).
10. Connect the secondary wires to the fixture using the provided Wago Connectors (B)

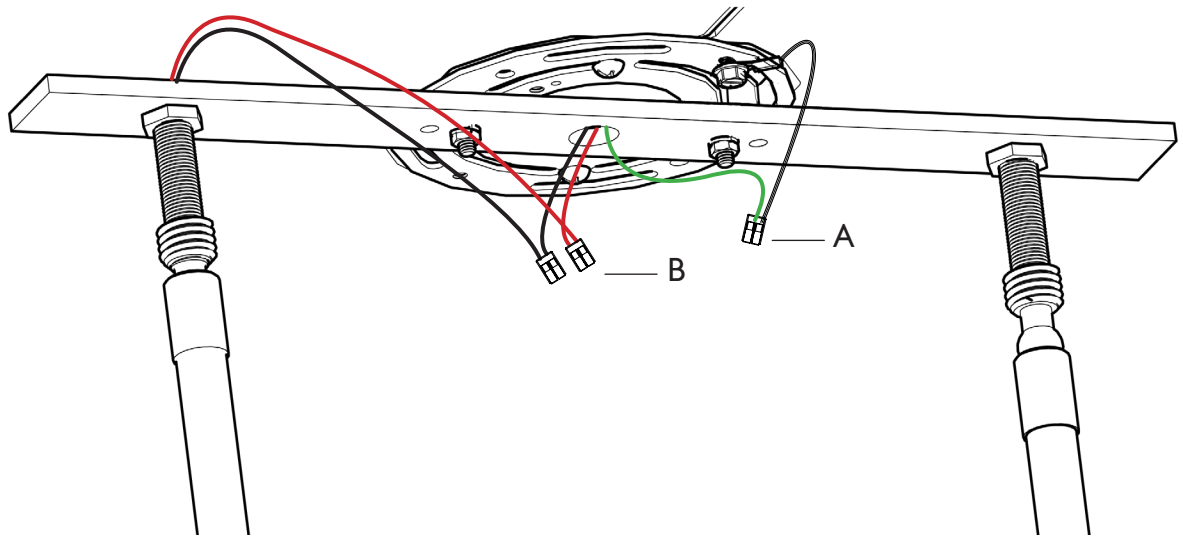

## APOLLO | INSTALLATION

---

11. Once properly wired, nestle the wires comfortably into the interior liner of junction box. Raise and secure the canopy (A) with the threaded collars (B), threading them on until the canopy is flush with the ceiling.

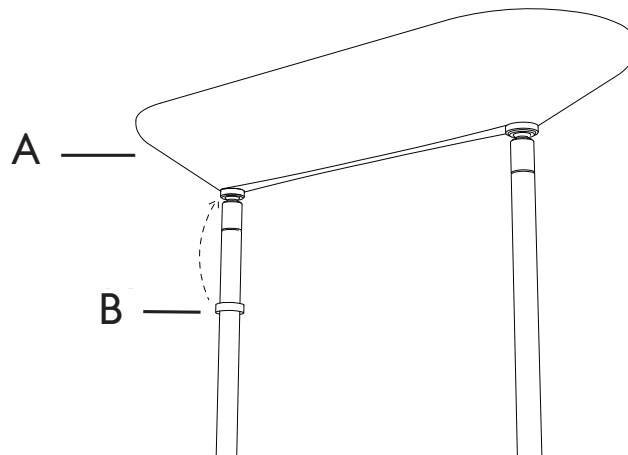

12. Insert the two leads from the LED bulbs (C) into the sockets (D) as shown below. Then carefully thread the glass diffuser (E) in place.

