

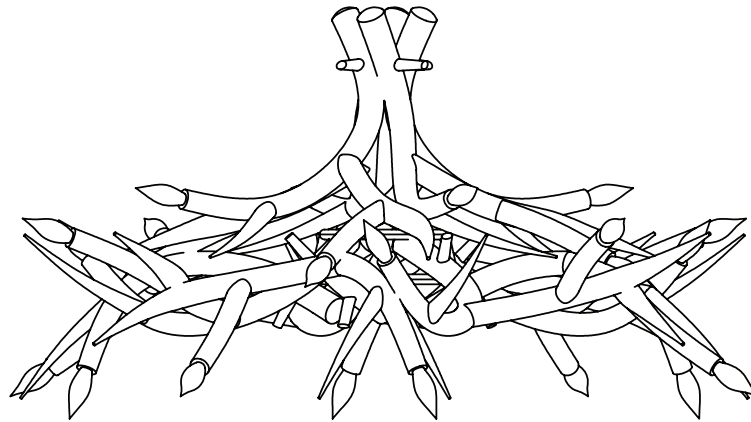

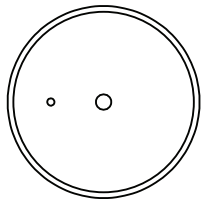



## CONTENTS

---

Superordinate Antler Chandelier - 12 Antlers



<p>Canopy</p> 	<p>Crossbar</p> 	<p>1/4-20 Threaded Rod</p> 	<p>Aircraft Cable</p> 
<p>Hanging Hardware</p> 	<p>E12 Bulbs                      120V (bulbs included)                      240V (bulbs not included)</p> 	<p>8-32 Screws (2)</p> 	

## SAFETY INFORMATION

---

- Only one light bulb per socket.
- Only suitable for direct mounting on non-combustible surfaces.
- Under no circumstances can Superordinate Antler Fixtures be mounted on normally flammable surfaces.
- Suitable for dry, indoor use only.
- Maximum ambient temperatures: 25° C

## SUPERORDINATE ANTLER CHANDELIER 10, 12, AND 24 INSTALLATION

*Note: Please contact a licensed electrician.  
Note: Do not use bulbs that exceed 25 watts.*

1. Remove and discard the temporary shipping cable by pressing down on the top of the cable hanger (E) and pulling it all the way out.
2. Attach the supplied aircraft cable by pressing down on the top of the cable hanger (E) and feeding it through. Cut the excess cable once the fixture is at the desired height.
3. Install the crossbar using #8-32 screws to junction box (A). It is recommended to make the wire connections after installing the crossbar (B).
4. Once the crossbar is secure, tuck the connected wires into the Junction box (A) and raise the canopy (C). Tighten flush to ceiling with cable nut (D).

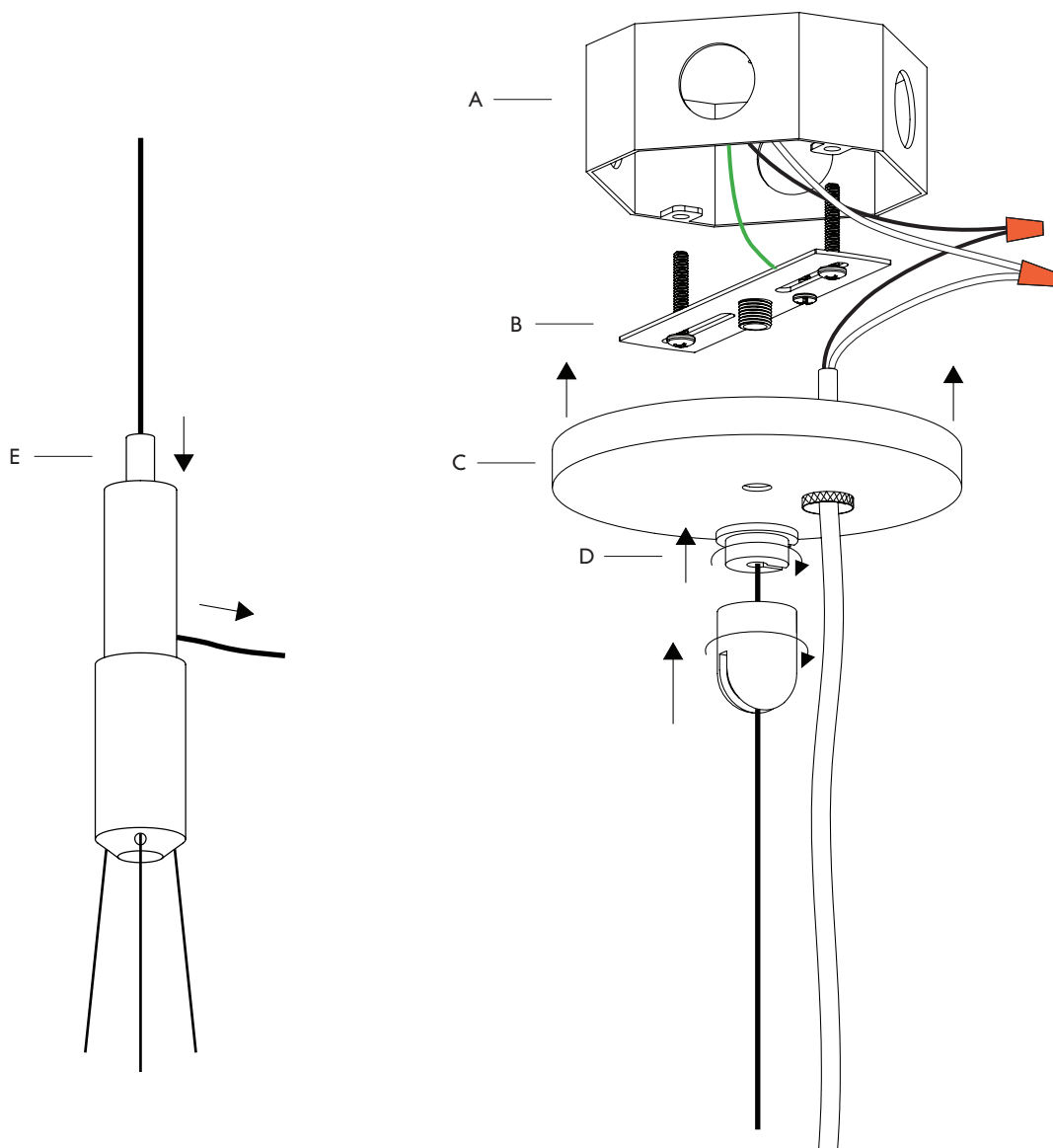

## REPLACING BULB

---

*Note: Make sure to power off fixture and allow bulbs and porcelain arms to cool.*

1. To change the halogen E12 bulb (A) unscrew bulb from fixture (B) and replace.

